

Rainwater Collection Unit

William Felinski, Manuel Advisory, Capstone 2012

Backdrop

- Tinkering
- Engineering class
- Dominican Republic

Inquiry

- Places
- People

Reflection

- Experience
- Problem

Research

- **Water availability**
- **Collection methods**
- **Purification**

Presentation

- **Housing**
- **Barrels, buckets, bowls**
- **Solar water disinfection**

System

- PET - Polyethylene terephthalate



Idea

- **Collection**
- **Easy, modular, and inexpensive**

Drafting

- Bags
- Tents
- Tripods
- Buckets
- Umbrellas

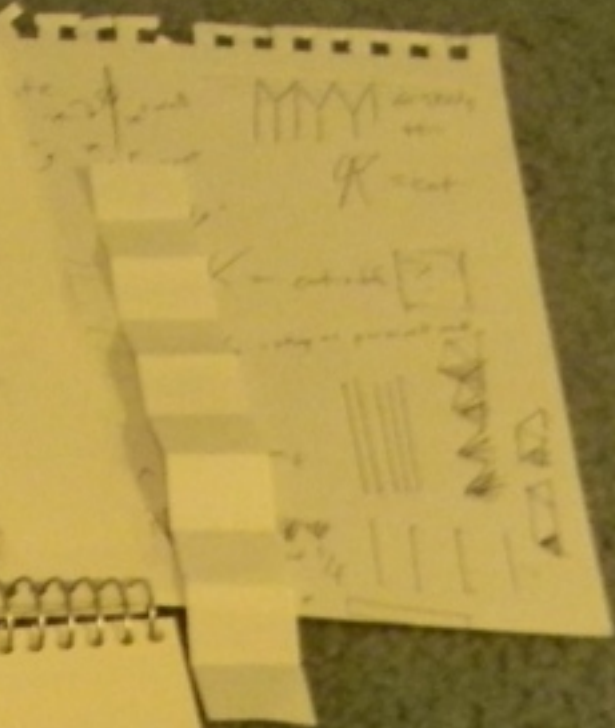
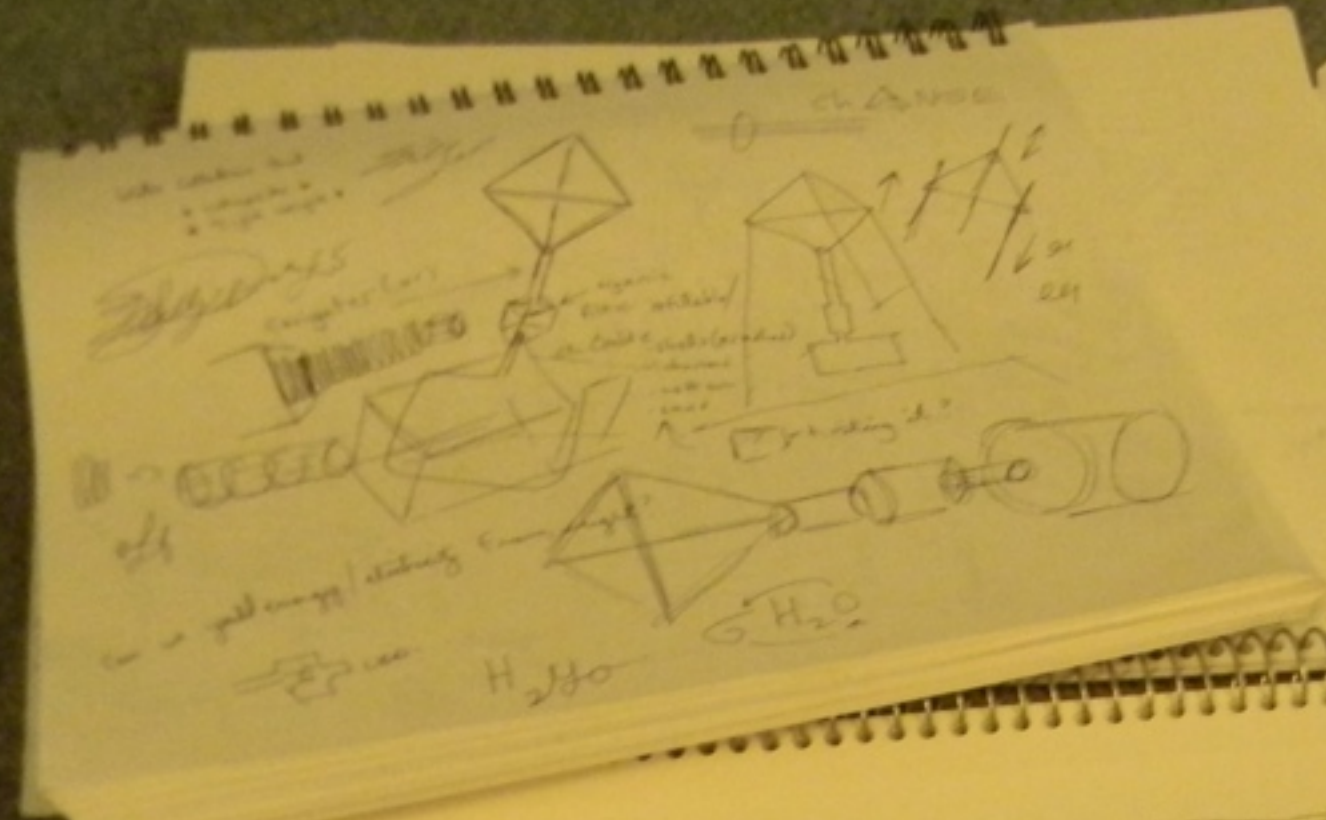

Run water treatment O.K.

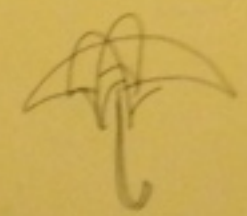
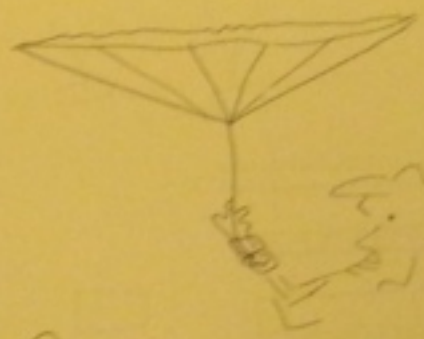
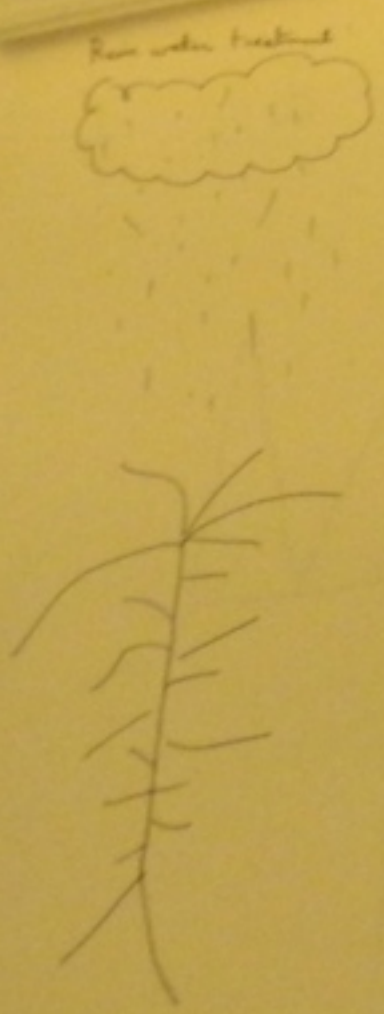

attach communal water collection

regener collection water

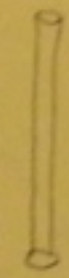

F₀

F₁

F₂

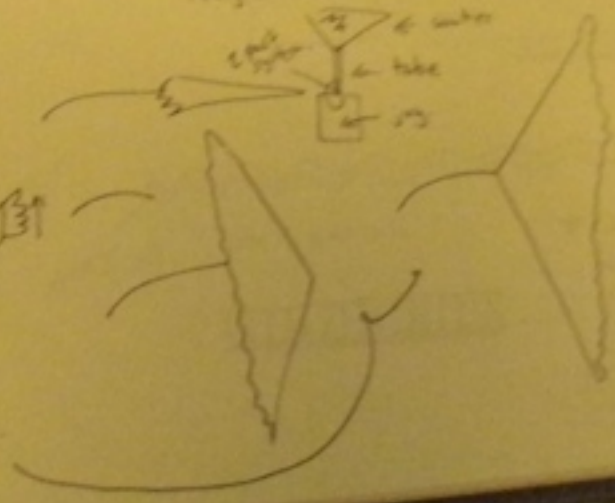

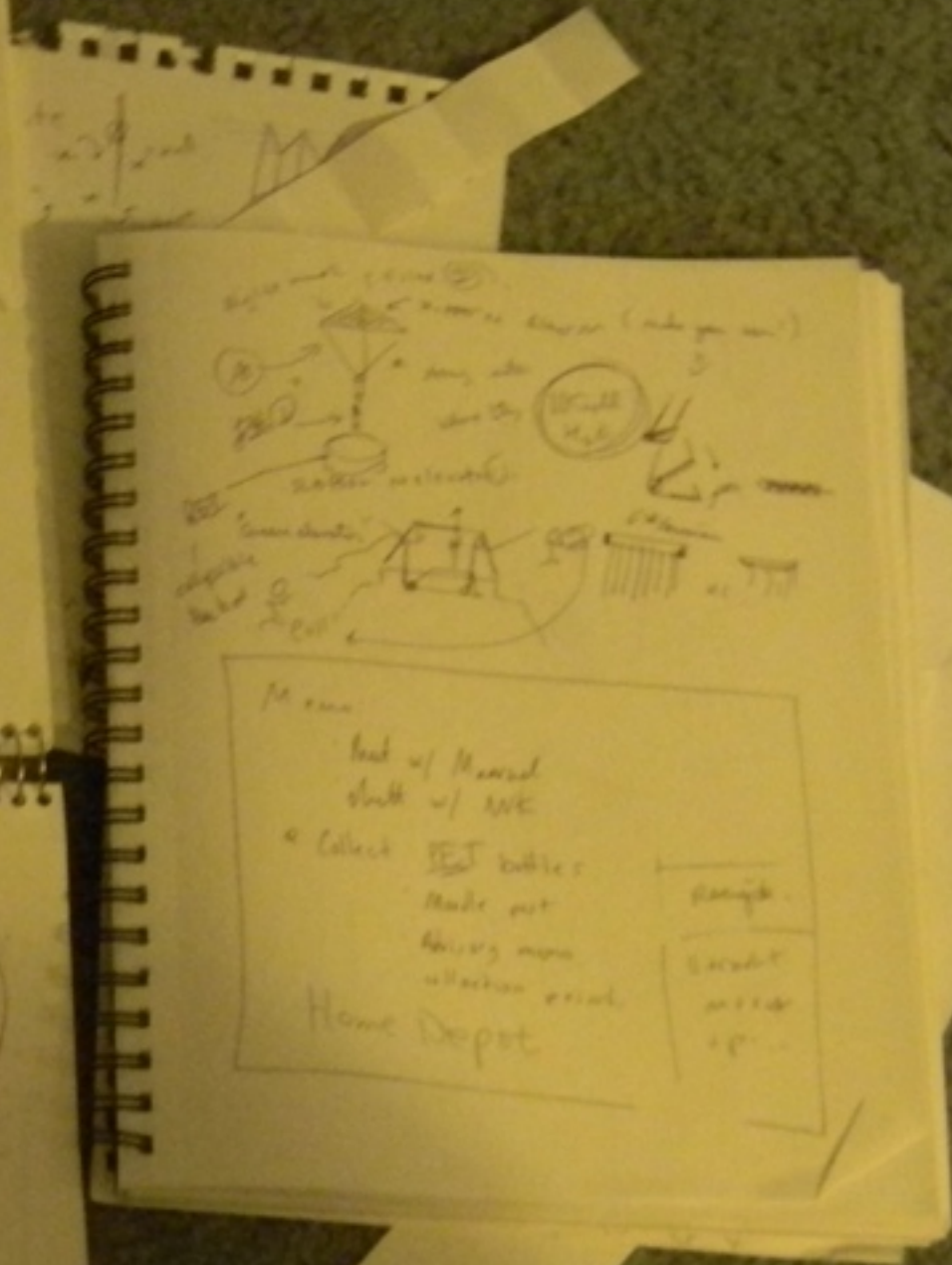
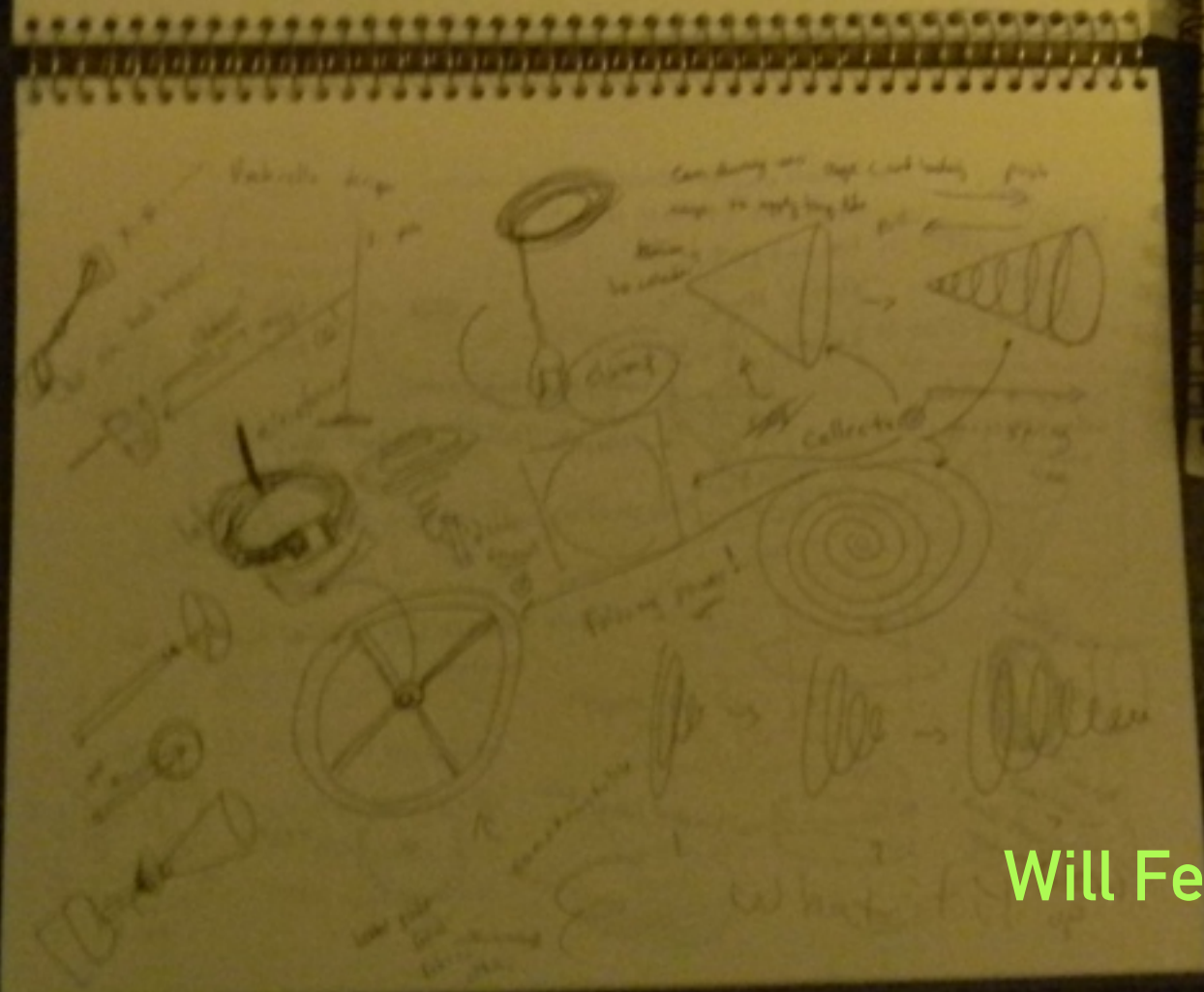
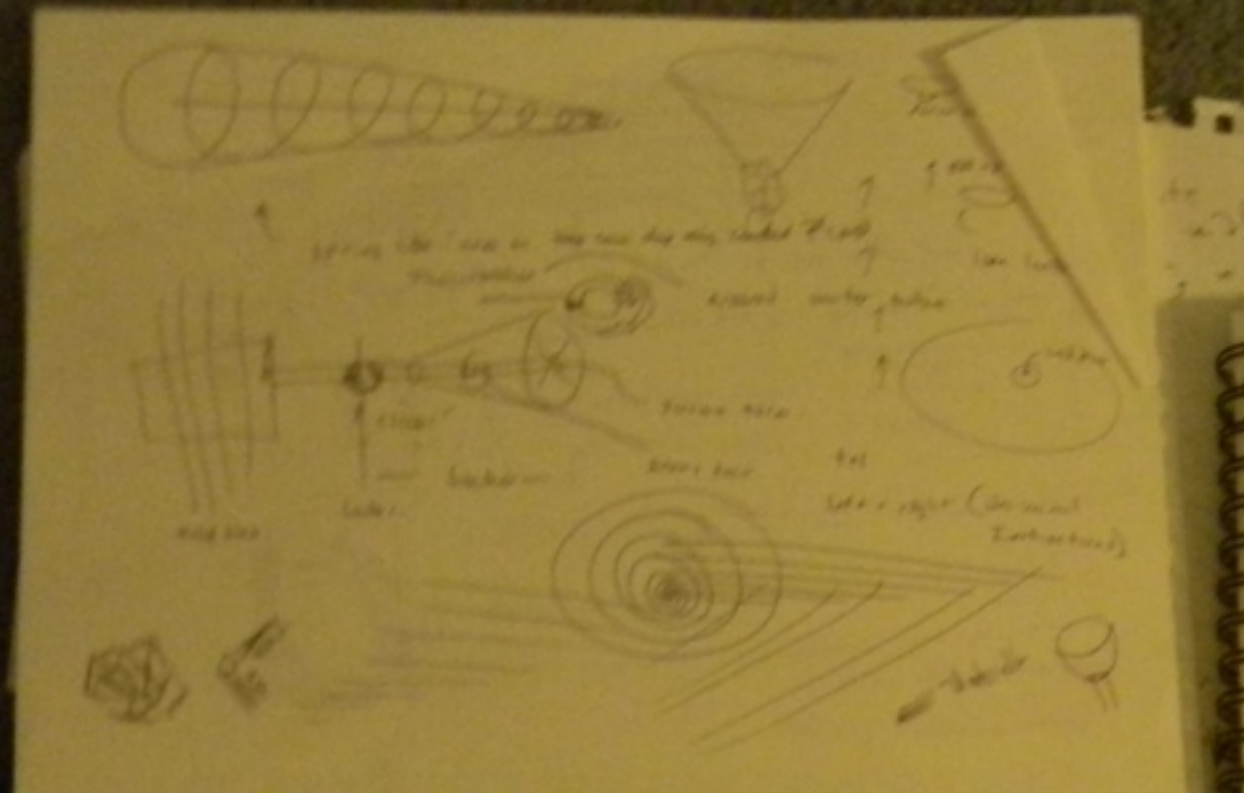

10 min
 End of Market
 Start of 1st
 Collect 1st bottles
 Make pot
 Having more
 attention around
 Home Depot

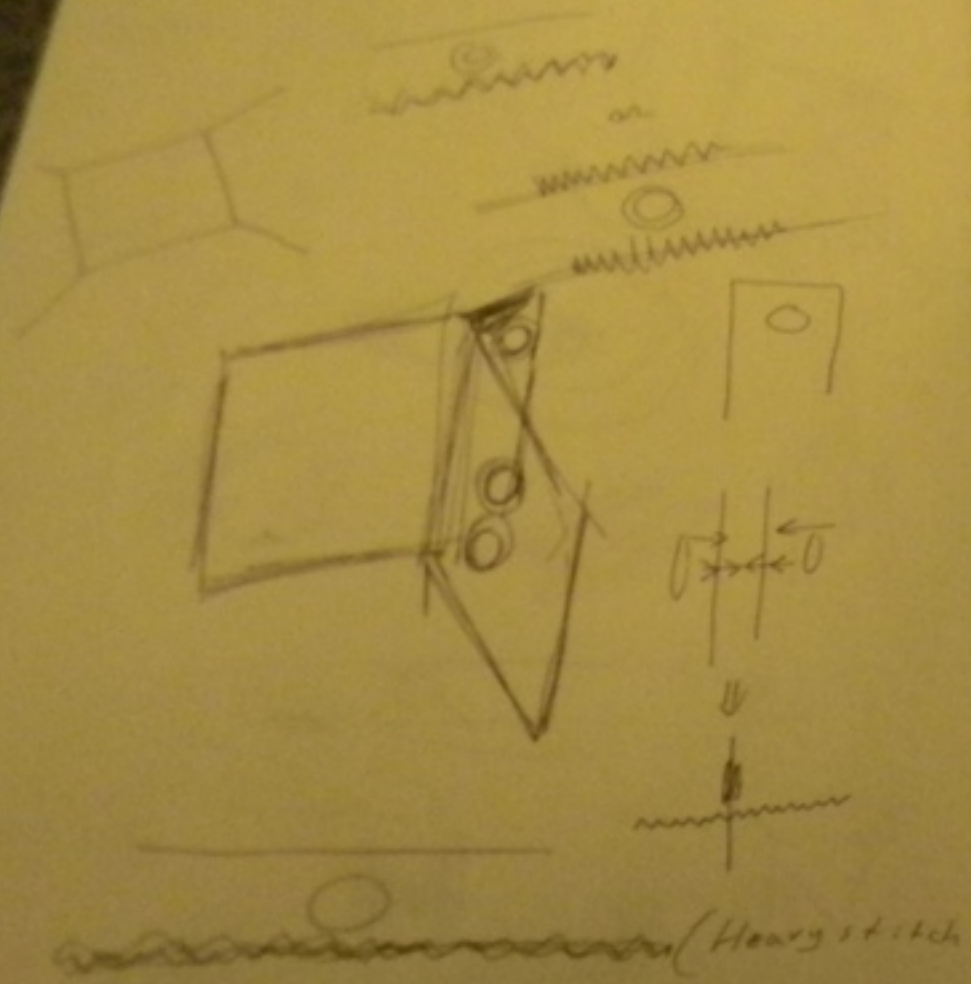

Longing strip

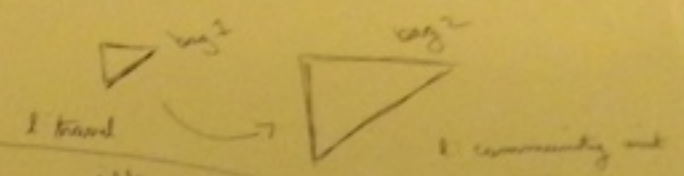

Matrix stability

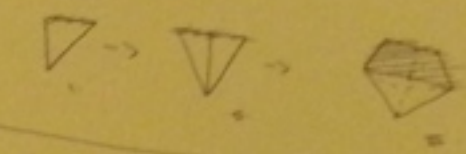

Real Time Delay Band

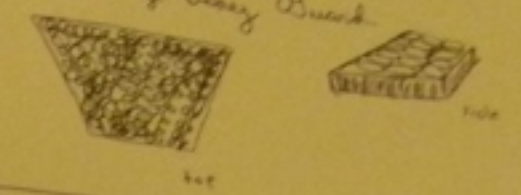

Temp water collecting infrastructure system w/

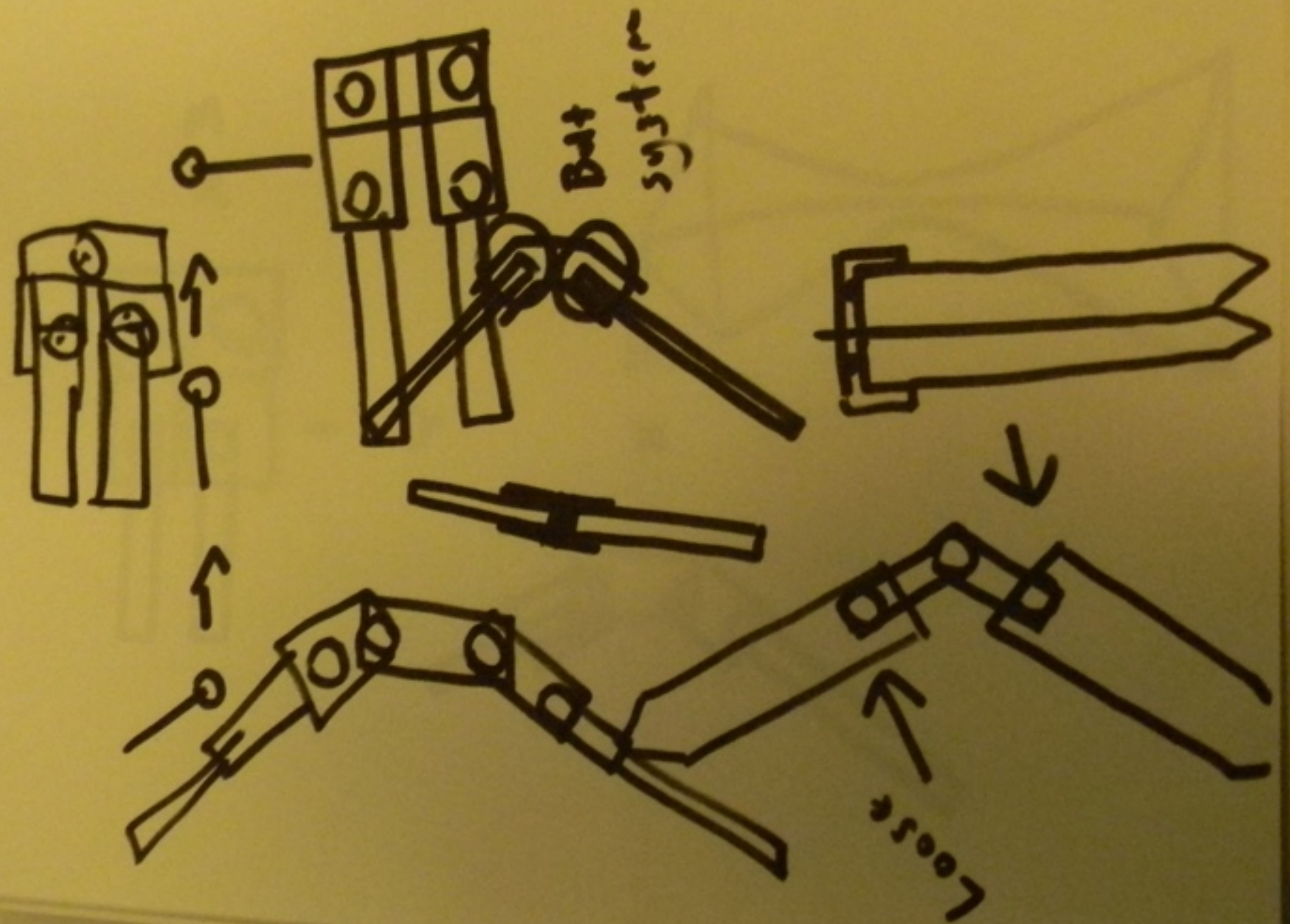

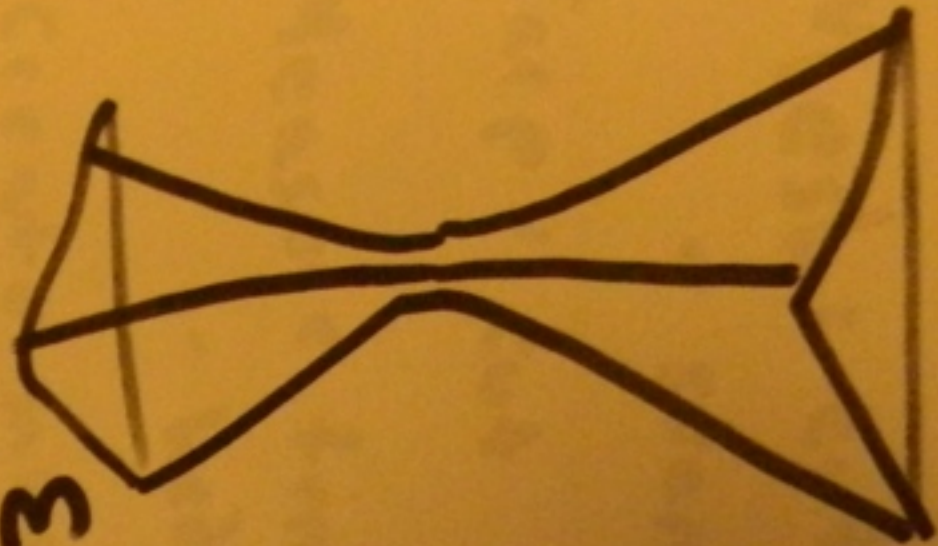
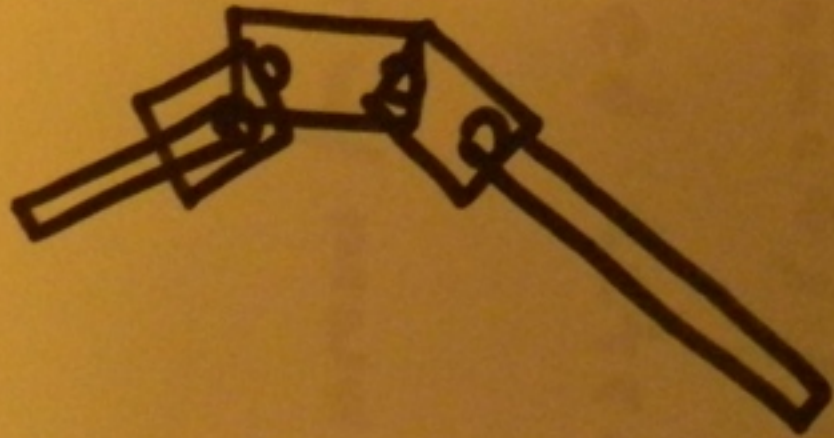
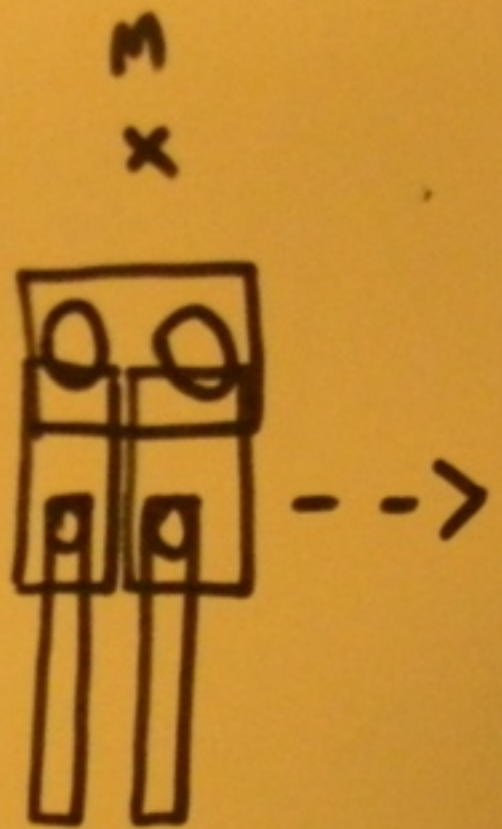

Idea Update

- Valve
- Tarps
- Ropes
- Filtration

Computer Draft

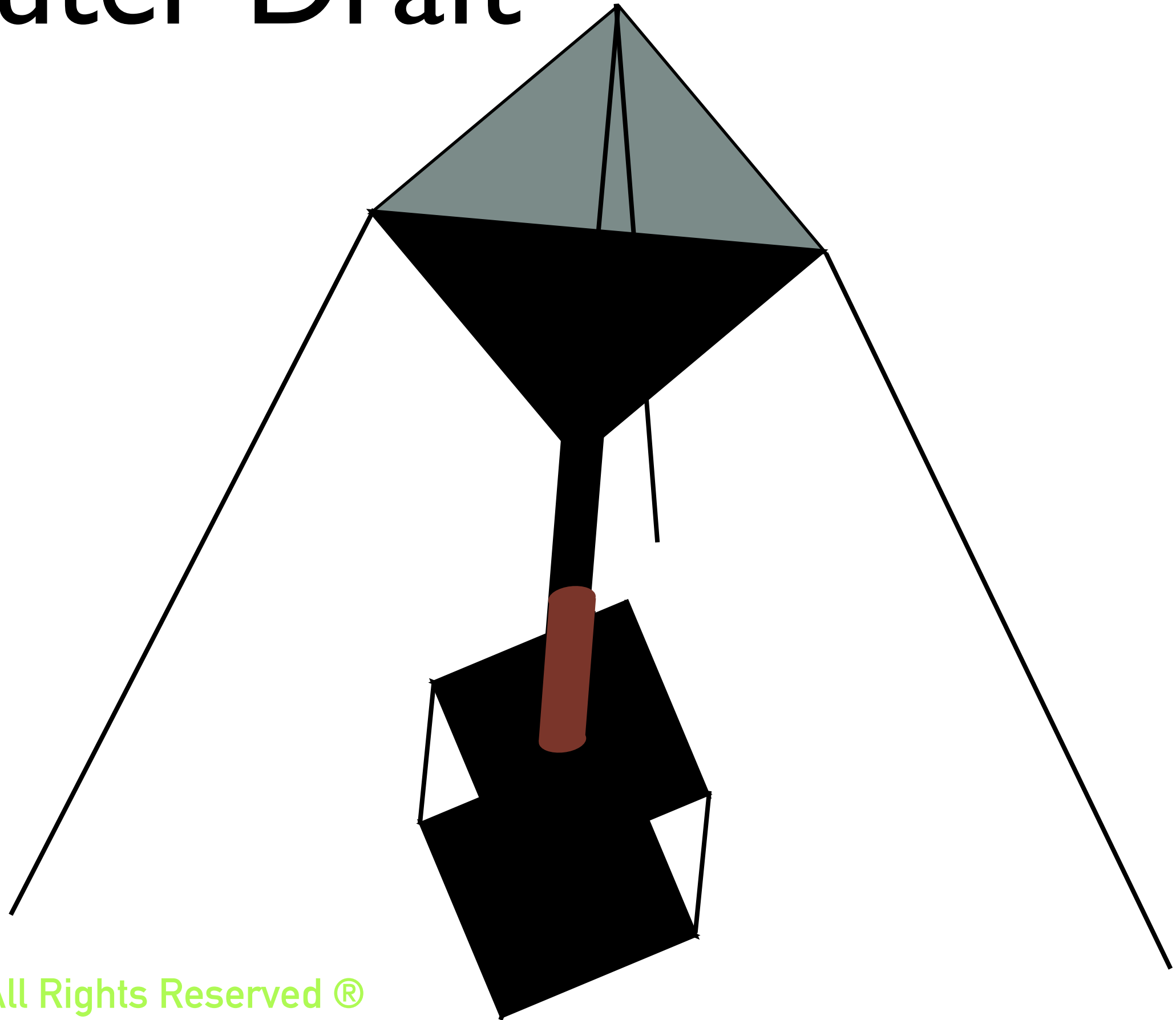

Materials

- Tarp
- Mesh
- Tube
- Ball valve
- Collapsible jug
- Rope
- Spigot
- Duct tape
- PVC pipe
- Silicone glue
- O-ring
- Tarp clips
- Hose clamp
- Activated charcoal
- Filter netting
- PVC fittings

Will Felinski, All Rights Reserved ©



Will Felinski, All Rights Reserved ©



Final Unit

- 9lbs
- Rope sling
- Water proof bag
- \$58.00 USD Material
- \$25.00 USD per Unit

Consumer Retail Market

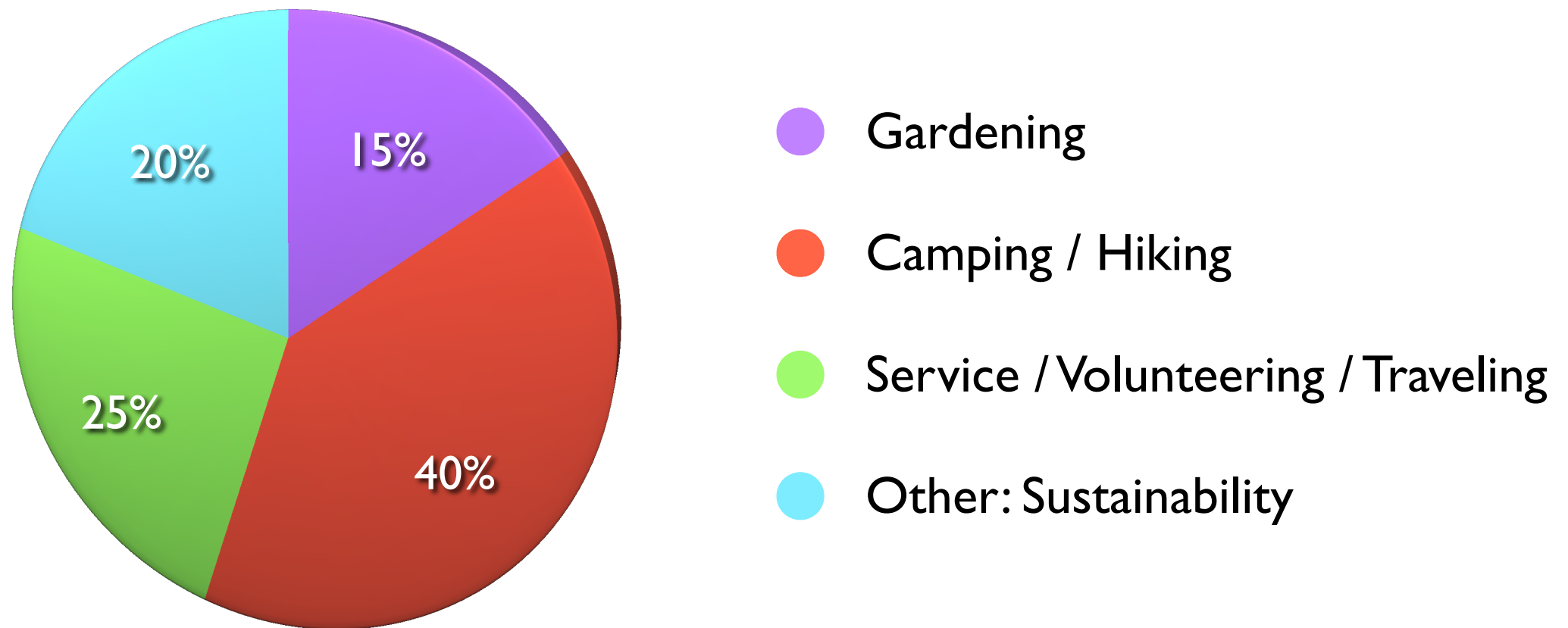

Key Places of Implementation

- India
- China
- Columbia
- Costa Rica
- Dominican Republic

Southeast Asia
Latin America

Advantages

- Lightweight
- Community based
- Nomadic oriented
- Various styles of usage

Solutions

- Tie off to trees
- Great on palm trees
- Works without level ground
- Stores up to 8.5 gallons of water
- Half of the people on Earth need water
- 300 Million people in China alone

Demonstration

Back of the room

Acknowledgments

Mr. W. W. Felinski III

Mr. M. VK

Ms. M. Manuel

Mrs. E. Small, Ph.D.

Mrs. C. R. Bleistine

Mr. D. Addison, Ph.D.

Mr. B. Pelleg, Ph.D.

Ms. A. Buhl

Retail Stores

- **REI**
- **LOWE'S**
- **CABELAS**
- **WALMART**
- **STANLEY HARDWARE - Philadelphia**